



AC AIR COMPONENTS S DE RL DE CV

AV. SALVADOR NAVA MTZ #1123
CONSTITUYENTES
C.P. 78388
SAN LUIS POTOSI, S.L.P

TEL / FAX 01-444-808-91-02
01-444-166-39-57

E-mail:
contacto@acaircomponents.com

www.acaircomponents.com

COMPRESORES COMPLETOS	5
COMPRESOR 906 DOBLE LAINA (CON CORTADORES)	8
COMPRESOR 906 DOBLE (SIN CORTADORES)	10
COMPRESOR 906 DOBLE T/N.....	12
COMPRESOR 457 MULTEGO DOBLE (911 02 10)	13
COMPRESOR 457 MULTEGO DOBLE T/N	15
COMPRESOR 457 MB CABEZA VOLADA	16
COMPRESOR 457 SENCILLO	18
COMPRESOR 457 SENCILLO T/VIEJO	20
COMPRESOR 904 MB	21
COMPRESOR 904 MB T/N	23
COMPRESOR 906 CARGA	24
COMPRESOR 447	26
COMPRESOR LK 15	26
COMPRESOR KNORR VOLVO 7550 LK 4918, 4919, 4922, 4927 LP 4986, 4989, 4990, 4993, 4996, 4997	27
COMPRESOR KNORR SCANIA LP 4957, 4963, 4964, 4965, LK 4941 COMPRESOR KNORR VOLVO LP 4930, 4974, 4934, 4949, 4967, 4968	28
COMPRESOR VOLVO 8300	29
COMPRESOR VOLVO 9700	30
COMPRESOR VOLVO 9800	32
COMPRESOR AUTOBUS VOLVO CAMA BAJA LK4954	34
COMPRESOR VOLVO LP 3970	35

COMPRESOR LK39, LP39 (EURO4, EURO5, MAN)	36
COMPRESOR MAN LK8901	37
COMPRESOR LK 38... MAN DOBLE	40
COMPRESOR KNORR 720/SCANIA LK4930.....	42
COMPRESOR SCANIA LK4949.....	42
COMPRESOR MAN / VW	43
COMPRESOR KNORR VW	44
COMPRESOR KNORR VW DOBLE	45
COMPRESOR MAX FORCE	45
COMPRESOR INTERNATIONAL MWM EURO 3	46
COMPRESOR ISX,ISM, ISC	48
COMPRESOR ISX TIPO NUEVO	50
COMPRESOR ISX, ISC DOBLE PISTON	51
COMPRESOR ISB	52
COMPRESOR QSB, CAT/CUMMINS	54
COMPRESOR BA 921 SERIE 60	55
COMPRESOR BA-921 (CABEZA ALUMINIO 5 TORNILLOS)	57
COMPRESOR BA-921 DD15.....	59
COMPRESOR PACCAR / DAF	61
COMPRESOR HOLSET ELECTRONICO	62
COMPRESOR TRACTOR VOLVO DOBLE	63
COMPRESOR TRACTOR VOLVO CABEZA VOLADA	64

COMPRESOR VOLVO-MACK CABEZA VOLADA [65](#)

COMPRESOR TU-FLO 550/750 [66](#)

PISTON Y ANILLOS P/COMPRESOR [67](#)



COMPRESORES

290.01.1000 COMPRESOR 904



541.01.1000 COMPRESOR 904 T/N



287.01.1000 COMPRESOR 906



602.01.2000 COMPRESOR ISX



323.01.1000 COMPRESOR 906 DOBLE PISTON

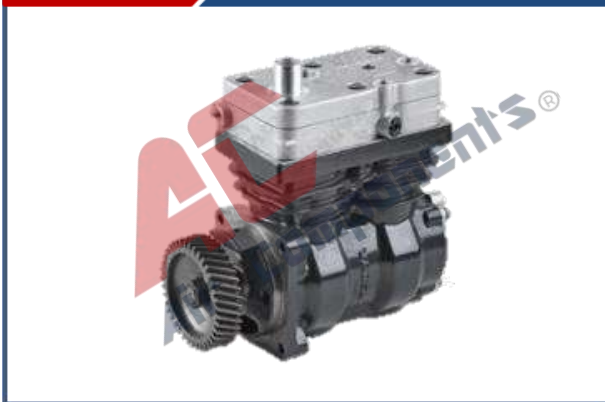

143.01.1000 VOLVO-MACK CABEZA VOLADA



COMPRESORES

138.01.1000 COMPRESOR VOLVO DOBLE



137.01.1000 COMPRESOR VOLVO VOLADA



171.01.1000 COMPRESOR SCANIA LK 4941



482.01.1000 COMPRESOR MAN LK8901



441.01.2000 COMPRESOR BA 921 DD15



672.01.1000 COMPRESOR BA-921 SERIE 60

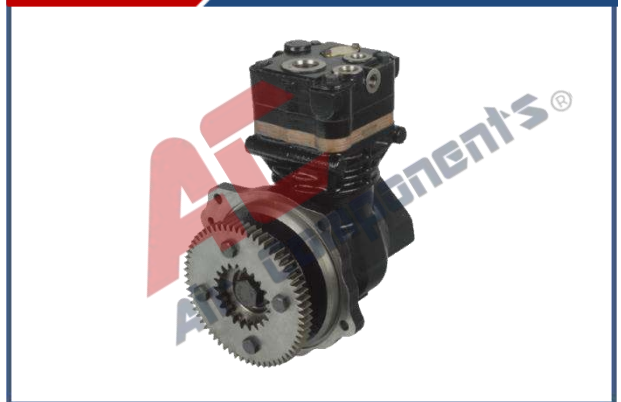

COMPRESORES

673.01.1000 COMPRESOR BA-921 5 TORNILLOS



256.01.1000 COMPRESOR LK 1808



190.01.1000 COMPRESOR VOLVO D13



669.01.2000 COMPRESOR ISX X15



234.01.1000 COMPRESOR PACCAR



COMPRESOR WABCO 906 DOBLE LAINA SEPARADA 85MM

296.01.1200 CABEZA DE COMPRESOR



296.01.1230 PLACA DE VALVULAS



296.01.2300 REPUESTO MAYOR CON BUJE



296.01.2350 REPUESTO MAYOR (9100 010 100)

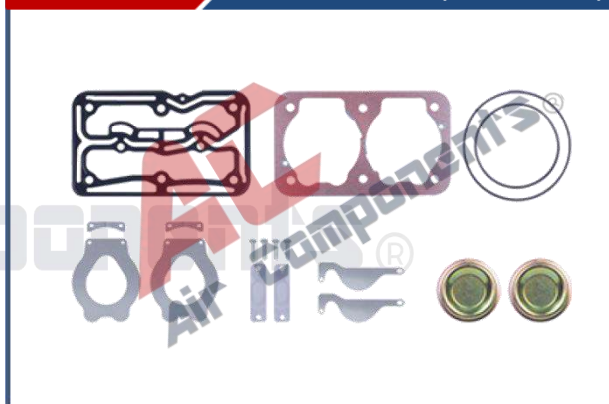

283.01.1600 TAPA TRASERA DE COMPRESOR



279.01.2600 BUJE



COMPRESOR WABCO 906 DOBLE LAINA SEPARADA 85MM

143.01.1400 BIELA



293.01.1580 TUERCA CIGÜEÑAL LH ROSCA IZQ



102.01.1580 TUERCA CIGÜEÑAL RH ROSCA DER



COMPRESOR WABCO 906 DOBLE (SIN CORTADORES)_{85MM}

322.01.1200 CABEZA DE COMPRESOR



321.01.1230 PLACA DE VALVULAS



299.01.1300 PLACA INTERMEDIA



322.01.2350 REPUESTO MAYOR

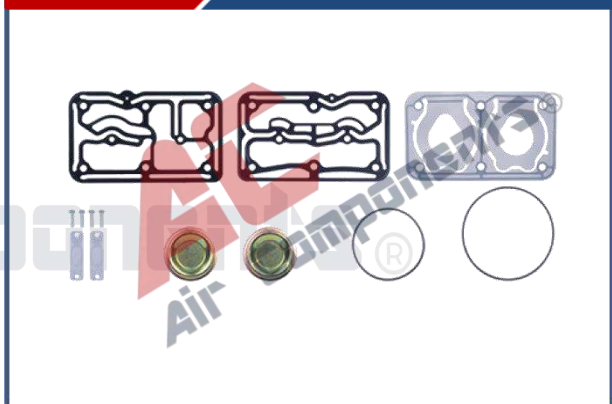

283.01.1600 TAPA TRASERA DE COMPRESOR



279.01.2600 BUJE



COMPRESOR WABCO 906 DOBLE (SIN CORTADORES)_{85MM}

143.01.1400 BIELA



293.01.1580 TUERCA CIGÜEÑAL LH ROSCA IZQ



102.01.1580 TUERCA CIGÜEÑAL RH ROSCA DER



COMPRESOR WABCO 906 DOBLE T/N

85MM

302.01.2350 REPUESTO MAYOR



283.01.1600 TAPA TRASERA



143.01.1400 BIELA



279.01.2600 BUJE



293.01.1580 TUERCA CIGÜEÑAL LH ROSCA IZQ



279.01.2900 ENGRANE



COMPRESOR 457 MULTEGO DOBLE (911 02 10) 85MM

310.01.1200 CABEZA DE COMPRESOR



310.01.1230 PLACA DE VALVULAS (911 02 12)



310.01.2350 REPUESTO MAYOR

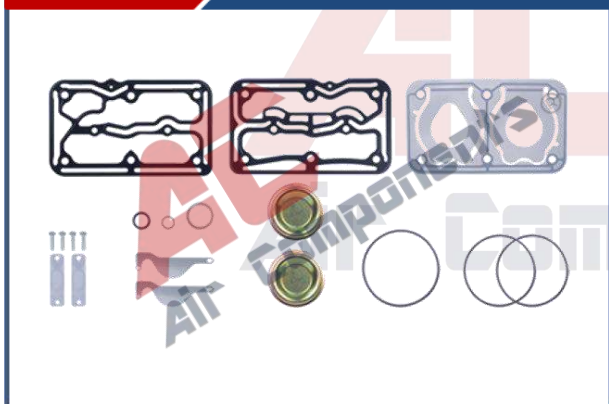

9100 020 150 REPUESTO MENOR

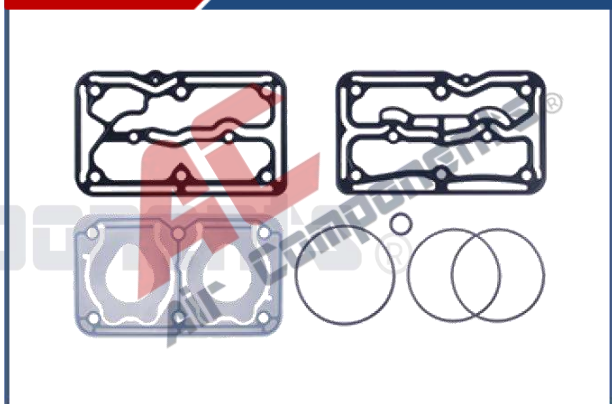

283.01.1600 TAPA TRASERA DE COMPRESOR



283.01.1610 BUJE



COMPRESOR 457 MULTEGO DOBLE (911 02 10) 85MM

143.01.1400 BIELA



293.01.1580 TUERCA CIGÜEÑAL LH ROSCA IZQ



102.01.1580 TUERCA CIGÜEÑAL RH ROSCA DER



COMPRESOR 457 MULTEGO DOBLE T/N

85MM

331.01.1200 CABEZA DE COMPRESOR



237.01.1230 PLACA DE VALVULAS



331.01.2350 REPUESTO MAYOR

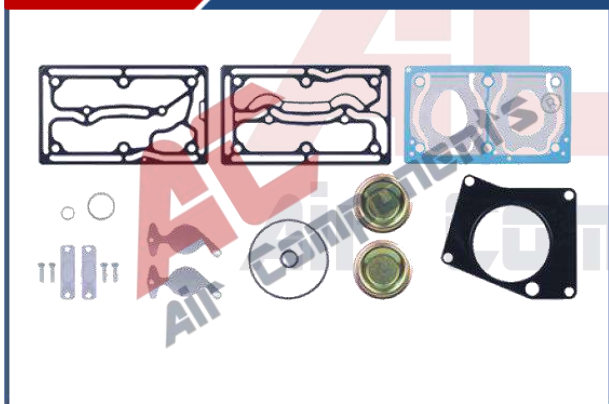

283.01.1400 BIELA



283.01.1600 TAPA TRASERA DE COMPRESOR



295.01.2106 EMPAQUE



COMPRESOR MB 457 CABEZA VOLADA

85MM

283.01.1200 CABEZA COMPRESOR (911 03 10)



283.01.1230 PLACA DE VALVULAS (911 03 12)



283.01.2350 REPUESTO MAYOR

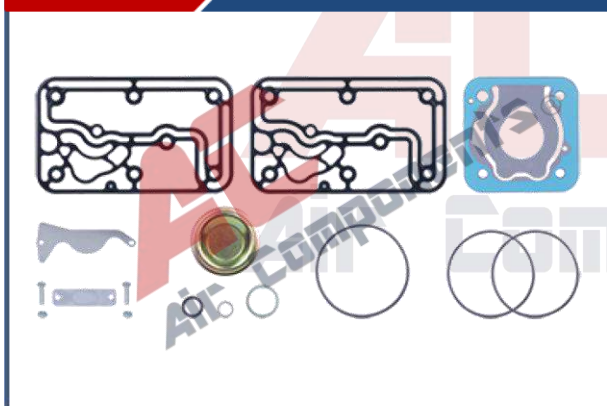

283.01.2100 REPUESTO MENOR

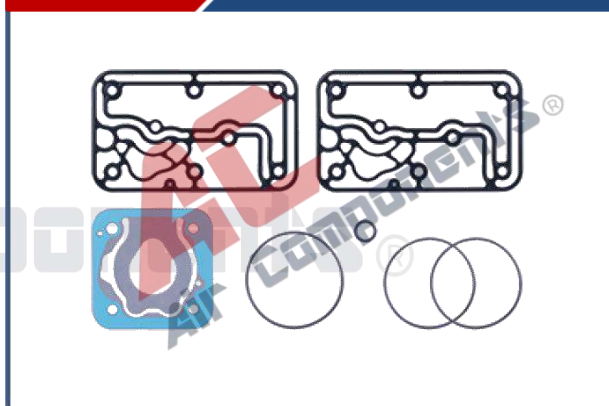

283.01.1600 TAPA TRASERA DE COMPRESOR



283.01.1610 BUJE



COMPRESOR MB 457 CABEZA VOLADA

85MM

283.01.1300 PLACA INTERMEDIA



295.01.2106 EMPAQUE



102.01.1580 TUERCA CIGÜEÑAL RH ROSCA DER



293.01.1580 TUERCA CIGÜEÑAL LH ROSCA IZQ



283.01.1400 BIELA



COMPRESOR 457 SENCILLO

85MM

280.01.1200 CABEZA DE COMPRESOR



280.01.1230 PLACA DE VALVULAS



280.01.2350 REPUESTO MAYOR



280.01.2300 REPUESTO MAYOR CON BUJE



102.01.1580 TUERCA CIGÜEÑAL RH ROSCA DER



293.01.1580 TUERCA CIGÜEÑAL LH ROSCA IZQ



COMPRESOR 457 SENCILLO

85MM

143.01.1400

BIELA

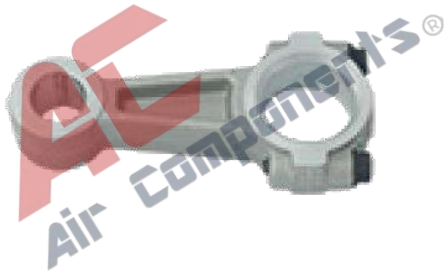

283.01.1600

TAPA TRASERA DE COMPRESOR



279.01.2900

ENGRANE



COMPRESOR 457 SENCILLO T/VIEJO

85MM



COMPRESOR WABCO 904 MB

85MM



COMPRESOR WABCO 904 MB

85MM

283.01.1400 BIELA CORTA



290.01.1400 BIELA LARGA



279.01.2600 BUJE

(904, 904 T/N, 906, 906 DOBLE)



293.01.1580 TUERCA CIGÜEÑAL LH ROSCA IZQ



279.01.2900 ENGRANE

(904, 904 T/N, 906, 906 DOBLE)



102.01.1580 TUERCA CIGÜEÑAL RH ROSCA DER



COMPRESOR WABCO 904 MB T/N

85MM

327.01.1200 CABEZA DE COMPRESOR



327.01.1230 PLACA DE VALVULAS



327.01.2350 REPUESTO MAYOR



327.01.2100 REPUESTO MENOR

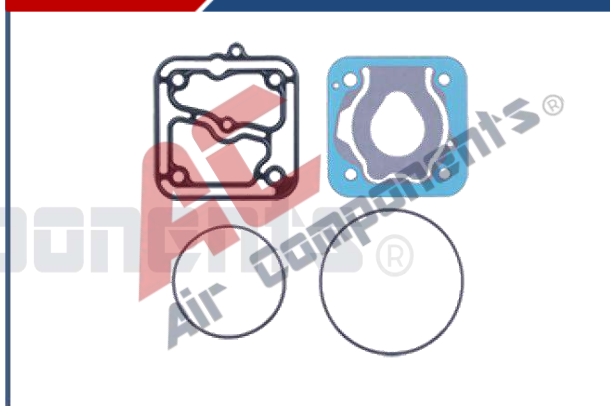

283.01.1600 TAPA TRASERA DE COMPRESOR



279.01.2600 BUJE

(904, 904 T/N, 906, 906 DOBLE)



COMPRESOR WABCO 906 CARGA

85MM

287.01.1200 CABEZA DE COMPRESOR



287.01.1230 PLACA DE VALVULAS



287.01.2350 REPUESTO MAYOR



287.01.2300 REPUESTO MAYOR CON BUJE



287.01.2100 REPUESTO MENOR



283.01.1600 TAPA TRASERA DE COMPRESOR



COMPRESOR WABCO 906 CARGA

85MM

143.01.1400 ▶ BIELA



279.01.2600 ▶ BUJE

(904, 904 T/N, 906, 906 DOBLE)



293.01.1580 ▶ TUERCA CIGÜEÑAL LH ROSCA IZQ



279.01.2900 ▶ ENGRANE

(904, 904 T/N, 906, 906 DOBLE)



102.01.1580 ▶ TUERCA CIGÜEÑAL RH ROSCA DER



COMPRESOR 447 *90MM*

COMPRESOR LK 15



COMPRESOR KNORR VOLVO 7550

88MM

LK 4918, 4919, 4922, 4927

LP 4986, 4989, 4990, 4993, 4996, 4997

116.01.1210 CABEZA DE COMPRESOR

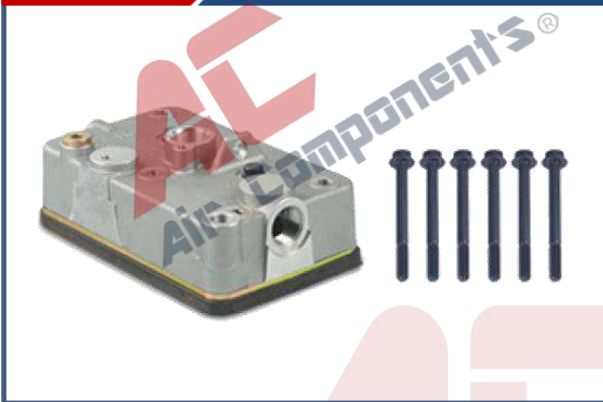

116.01.1300S PLACA DE VALVULAS

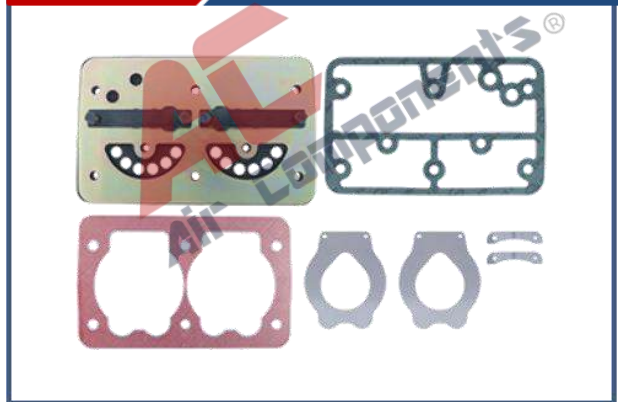

123.01.2350 REPUESTO MAYOR

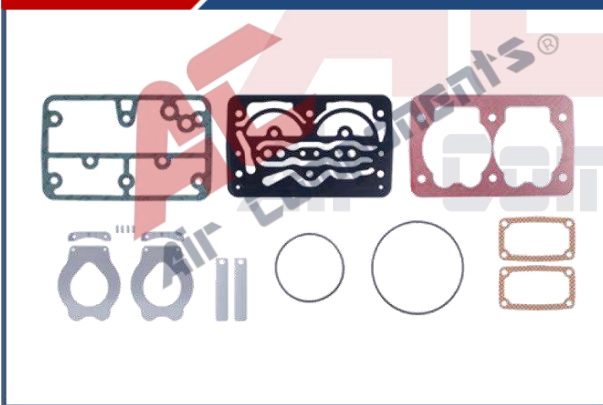

102.01.2600 BUJE



102.01.1580 TUERCA CIGÜEÑAL RH ROSCA DER



COMPRESOR KNORR SCANIA LP 4957, 4963, 4964, 4965, LK 4941
 COMPRESOR KNORR VOLVO LP 4930, 4974, 4934, 4949, 4967, 4968

88MM



COMPRESOR VOLVO 8300

85MM

147.01.1200 CABEZA DE COMPRESOR

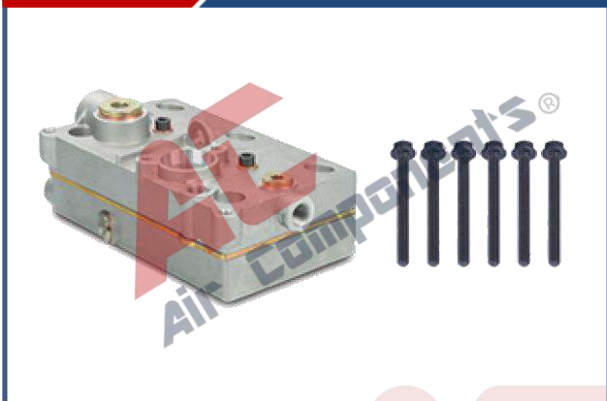

147.01.1230 PLACA DE VALVULAS



147.01.2350 REPUESTO MAYOR

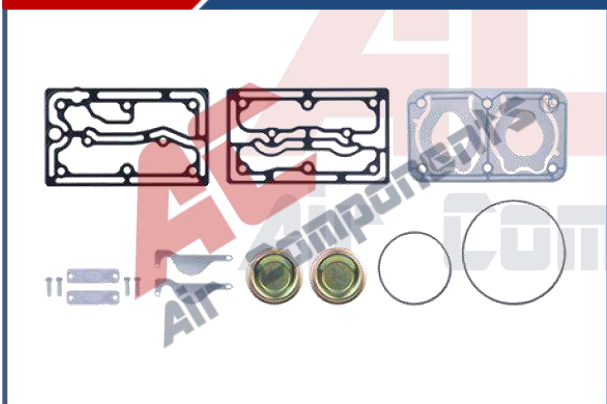

102.01.1580 TUERCA CIGÜEÑAL RH ROSCA DER



132.01.1400 BIELA



138.01.2600 BUJE



COMPRESOR WABCO PARA VOLVO 9700

85MM

139.01.1200 CABEZA DE COMPRESOR



913 19 12 PLACA DE VALVULAS



139.01.1300 PLACA INTERMEDIA



139.01.2350 REPUESTO MAYOR



143.01.1400 BIELA



102.01.1580 TUERCA CIGÜEÑAL RH ROSCA DER



COMPRESOR WABCO PARA VOLVO 9700

85MM



COMPRESOR WABCO PARA VOLVO 9800

85MM

210.01.1200 CABEZA DE COMPRESOR



139.01.1300 PLACA INTERMEDIA



210.01.2350 REPUESTO MAYOR

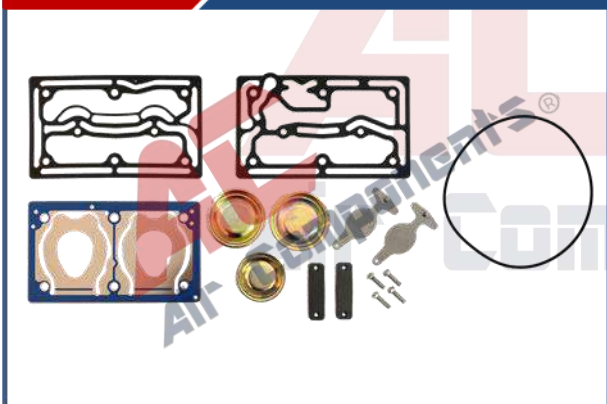

143.01.1400 BIELA



143.01.2600 BUJE



143.01.3600 ADAPTADOR



COMPRESOR WABCO PARA VOLVO 9800

85MM

102.01.1580

TUERCA CIGÜEÑAL RH ROSCA DER

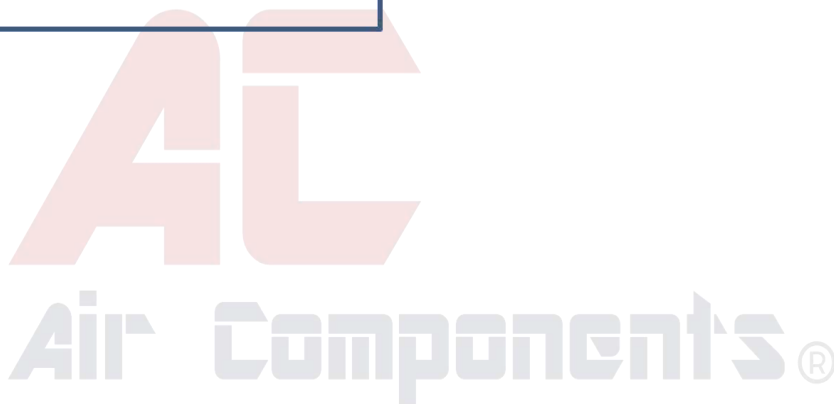

COMPRESOR AUTOBUS VOLVO CAMA BAJA LK4954 92MM

174.01.1210 CABEZA DE COMPRESOR

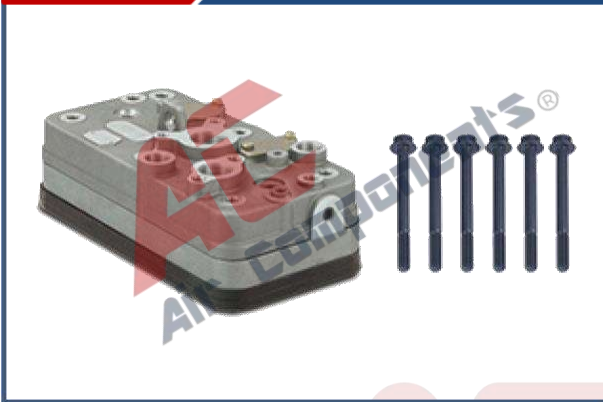

174.01.2350 REPUESTO MAYOR

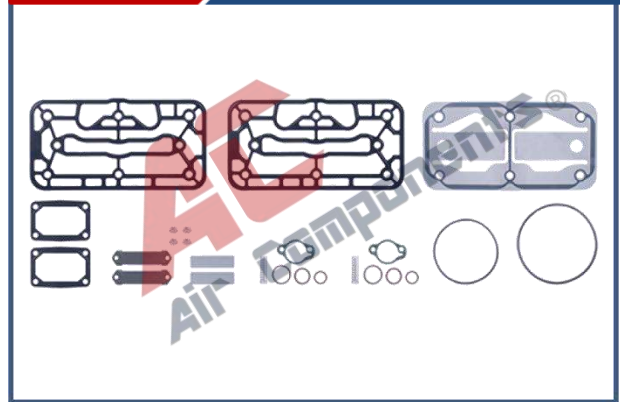

102.01.2600 BUJE



COMPRESOR VOLVO LP 3970

92MM



COMPRESOR LK 39,LP39 (EURO4, EURO5, MAN) 92MM

703.01.1200S TAPA



429.01.1300 PLACA KIT



429.01.2350 REPUESTO MAYOR

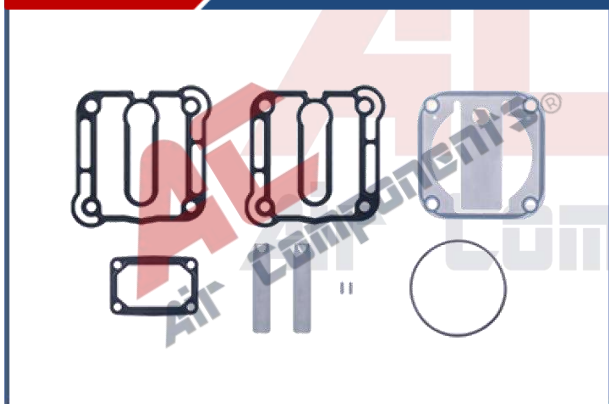

409.01.1400 BIELA



293.01.1580 TUERCA CIGÜEÑAL LH ROSCA IZQ



102.01.2600 BUJE



COMPRESOR MAN LK8901

92MM

265.01.1200 CABEZA DE COMPRESOR



307.01.1300 PLATO DE CABEZA

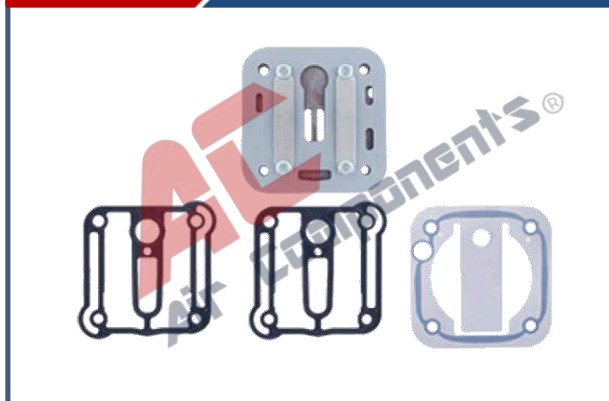

482.01.2350 REPUESTO MAYOR

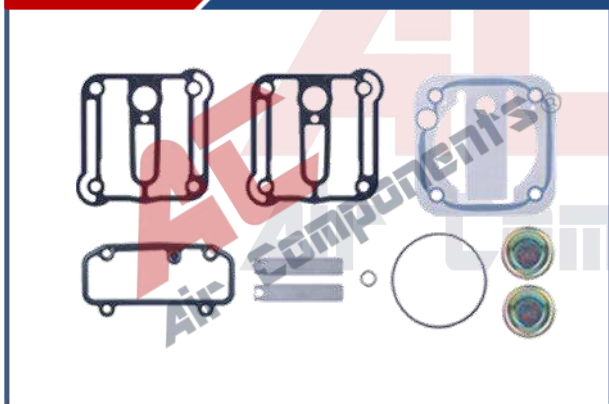

265.01.2900 ENGRANE



481.01.2910 ENGRANE



482.01.1100 CARCAZA



COMPRESOR MAN LK8901

92MM



COMPRESOR MAN LK8901

92MM

265.01.1510

TORNILLO CIGÜEÑAL



481.01.1502

TORNILLO EJE

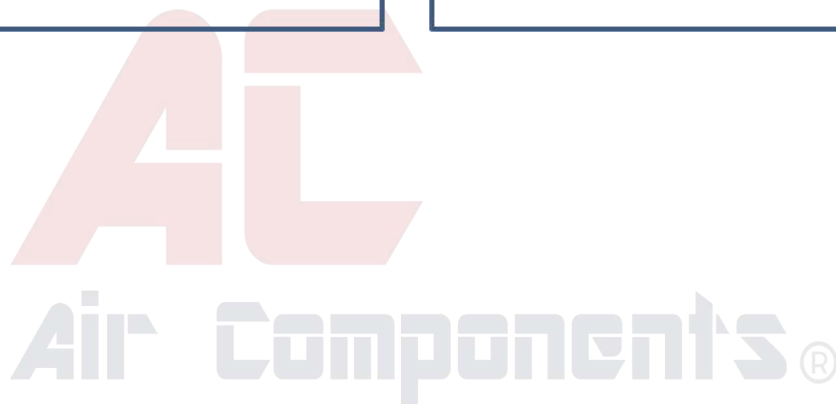

COMPRESOR MAN LK 38 MAN DOBLE

90MM

344.01.1210 CABEZA DE COMPRESOR



344.01.1300 PLATO Y REPUESTO



344.01.2350S REPUESTO PAPEL KLINGERIT

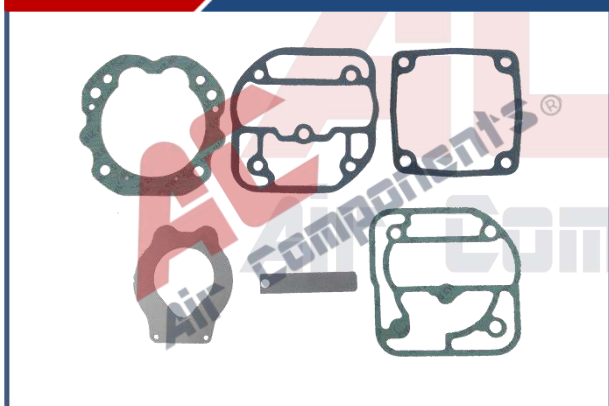

344.01.2350A REPUESTO CON PUENTE METALICO

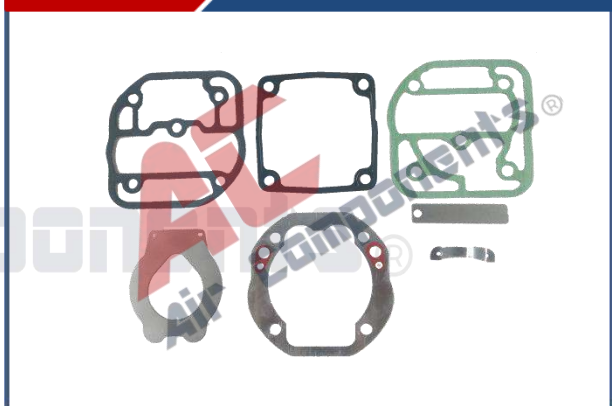

344.01.1200 TAPA DE CABEZA



328.01.1103 BALERO



COMPRESOR MAN LK 38 MAN DOBLE

90MM

352.01.2600

BUJE



367.01.1100

CARCAZA



409.01.1400

BIELA



COMPRESOR WABCO KNORR 720/SCANIA LK4930 92MM



COMPRESOR SCANIA LK4949



COMPRESOR MAN / VW

85MM

288.01.1200 CABEZA DE COMPRESOR



288.01.2350 REPUESTO MAYOR



102.01.1580 TUERCA CIGÜEÑAL RH ROSCA DER



283.01.1400 BIELA CORTA



290.01.1400 BIELA LARGA



COMPRESOR KNORR VW

80MM

245.01.1210 CABEZA DE COMPRESOR



434.01.2350 REPUESTO MAYOR



102.01.2600 BUJE



409.01.1400 BIELA



COMPRESOR KNORR VW DOBLE

86MM



COMPRESOR MAX FORCE

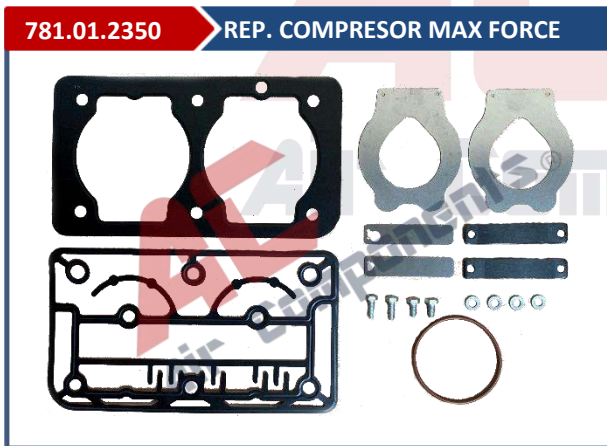

COMPRESOR INTERNACIONAL MWM EURO 3 88MM

344.01.1210S CABEZA DE COMPRESOR



344.01.1300 PLATO Y REPUESTO



344.01.2350S REPUESTO PAPEL KLINGERIT

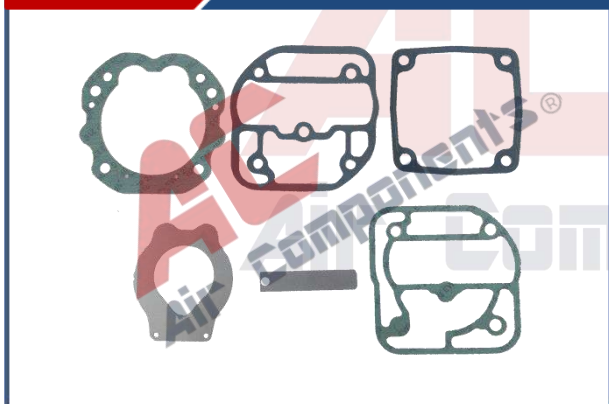

344.01.2350A REPUESTO CON PUENTE METALICO

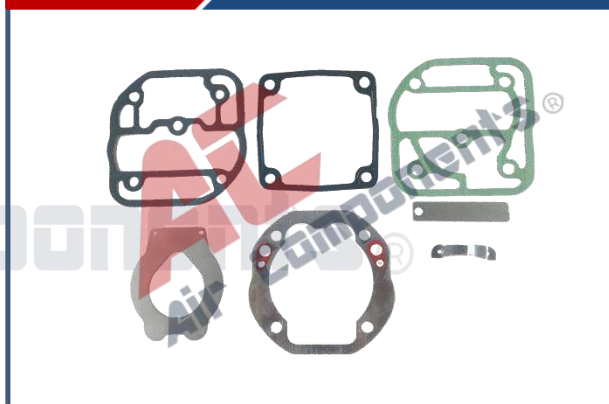

344.01.1200 TAPA DE CABEZA



257.01.2600 BUJE DELGADO



COMPRESOR INTERNATIONAL MWM EURO 3 88MM

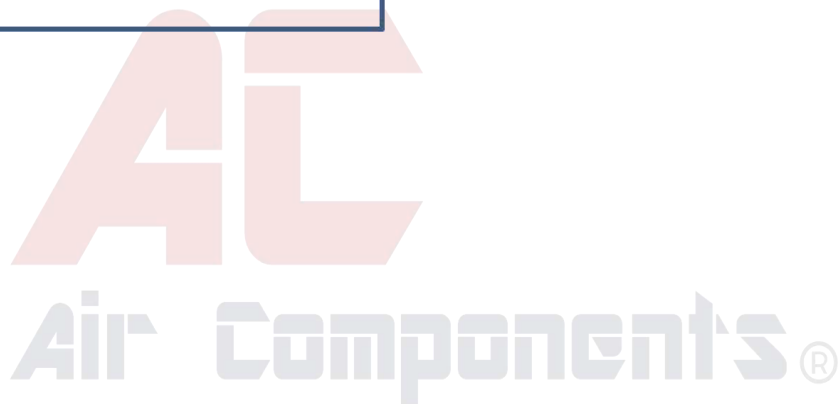

COMPRESOR WABCO ISX, ISM, ISC

85MM

601.01.1200 CABEZA ISC, ISM



601.01.1230 PLACA DE VALVULAS



602.01.1200 CABEZA ISX



601.01.2350 REPUESTO MAYOR



601.01.2300 REPUESTO MAYOR CON BUJE

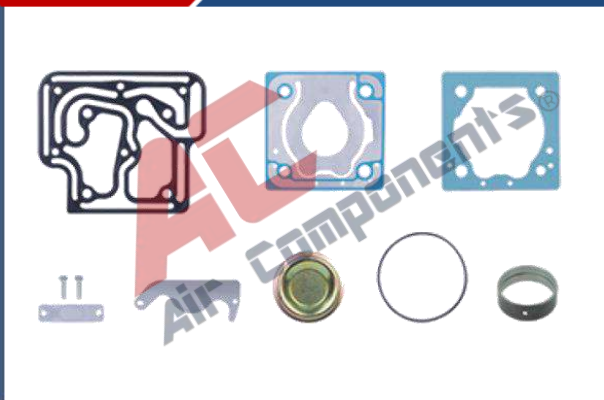

601.01.2100 REPUESTO MENOR



COMPRESOR WABCO ISX, ISM, ISC

85MM

143.01.1400 BIELA



602.01.2600 BUJE ANCHO



601.01.2600 BUJE DELGADO



602.01.1510 ADAPTADOR BOMBA



602.01.1502 TORNILLO CIGÜEÑAL



COMPRESOR WABCO ISX TIPO NUEVO

85MM



COMPRESOR WABCO ISX, ISC DOBLE PISTON 85MM

680.01.1200 CABEZA COMPRESOR ISX DOBLE



681.01.1200 CABEZA COMPRESOR ISC DOBLE



680.01.2350 REPUESTO MAYOR

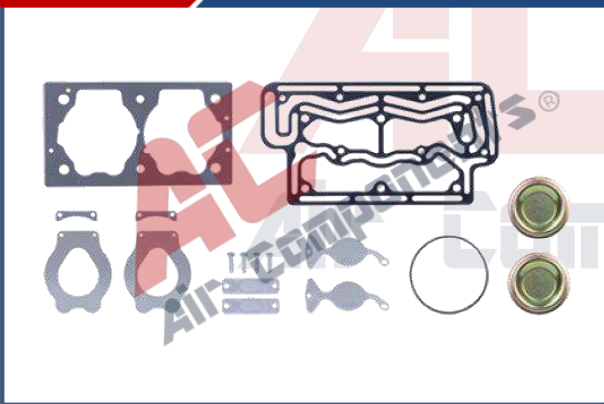

143.01.1400 BIELA



602.01.1510 ADAPTADOR BOMBA



COMPRESOR WABCO ISB

75MM

599.01.1200 CABEZA DE COMPRESOR



599.01.1230 PLACA DE VALVULAS

(925 09 12)



599.01.2350 REPUESTO MAYOR



599.01.2300 REPUESTO MAYOR CON BUJE



9500 090 150 REPUESTO MENOR



602.01.1510 ADAPTADOR BOMBA



COMPRESOR WABCO ISB

75MM



AC
Air Components®

COMPRESOR WABCO QSB, CAT/CUMMINS 75MM

583.01.1200 CABEZA DE COMPRESOR



599.01.1230 PLACA DE VALVULAS



599.01.2350 REPUESTO MAYOR



601.01.2600 BUJE



COMPRESOR BA 921 SERIE 60

92MM

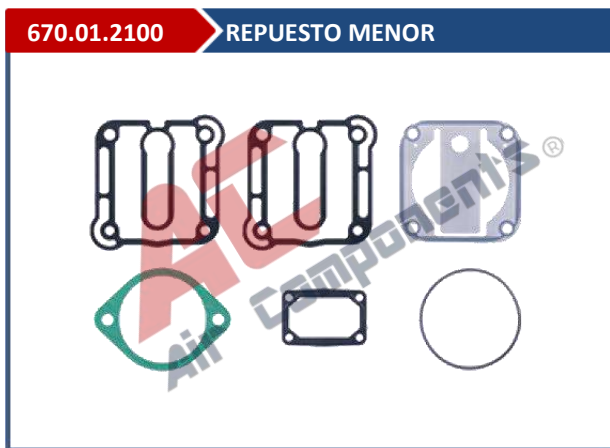

COMPRESOR BA 921 SERIE 60

92MM

670.01.2500 KIT DE VALVULAS



670.01.1400 BIELA



672.01.2600 BUJE



672.01.1103 BALERO



COMPRESOR BA-921 (CABEZA ALUMINIO 5 TORNILLOS) 92MM

673.01.1210 CABEZA CON PLACA



673.01.1200 CABEZA



441.01.1300 PLACA Y REPUESTO

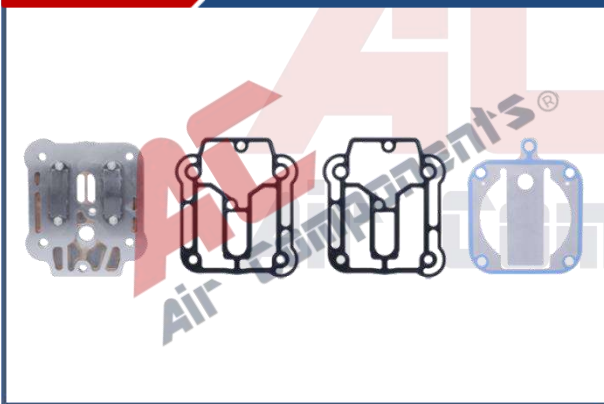

670.01.2500 KIT DE VALVULAS



673.01.2320 REPUESTO

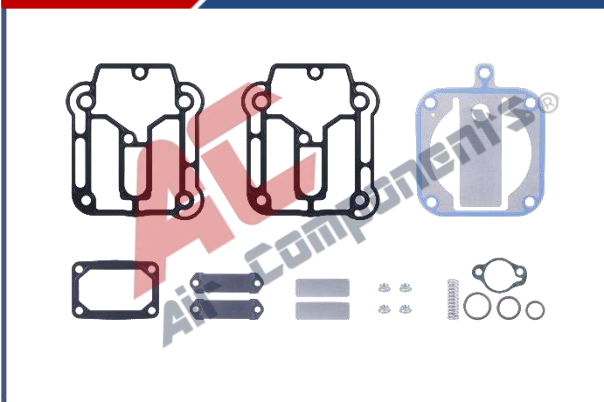

441.01.2320 REPUESTO CON TAPA

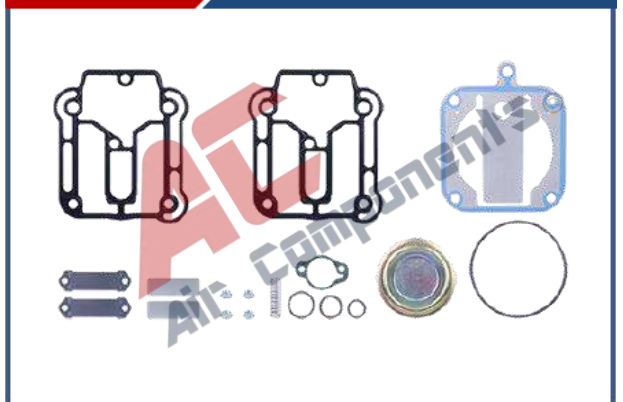

COMPRESOR BA-921 (CABEZA ALUMINIO 5 TORNILLOS) 92MM

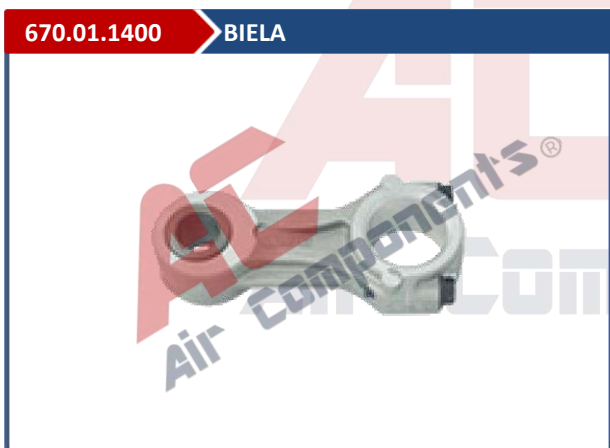

COMPRESOR BA-921 DD15

92MM

441.01.1200 CABEZA SIN PLACA



441.01.1300 PLACA Y REPUESTO

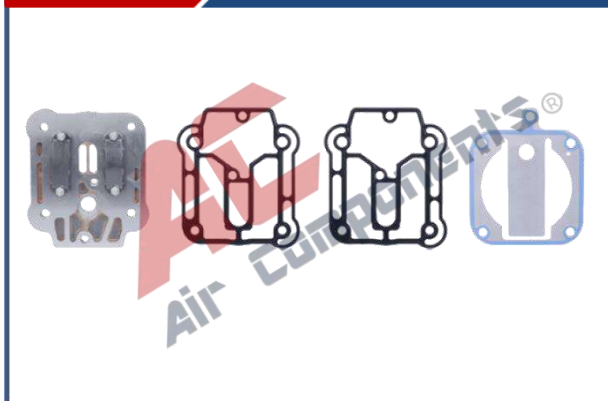

441.01.2320 REPUESTO CON TAPA

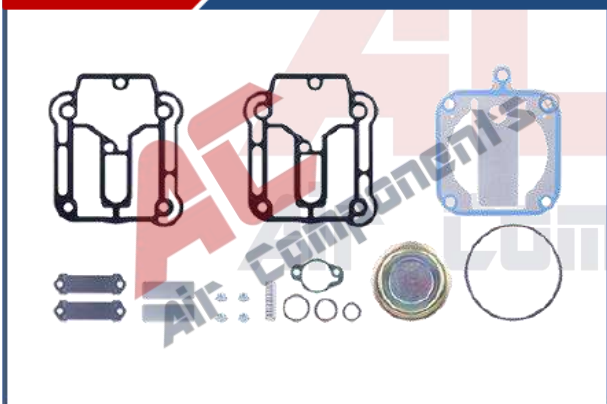

670.01.2500 KIT DE VALVULAS



409.01.1400 BIELA



172.01.1900 TAPA



COMPRESOR BA-921 DD15

92MM

293.01.1580

TUERCA CIGÜEÑAL LH ROSCA IZQ



441.01.1600

TAPA TRASERA

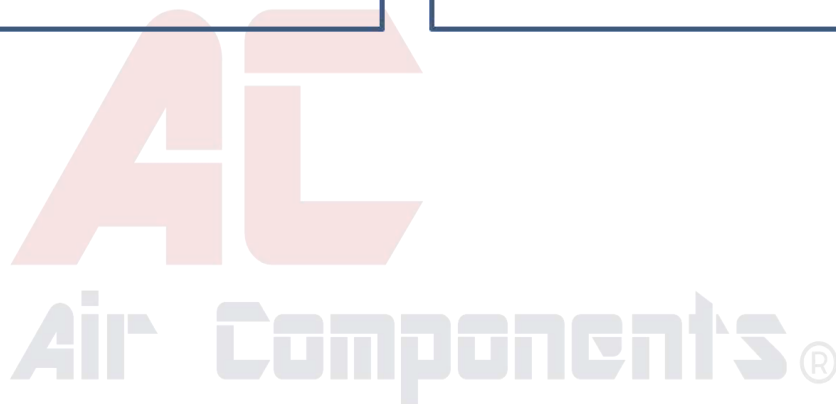

COMPRESOR PACCAR / DAF

237.01.1200 CABEZA

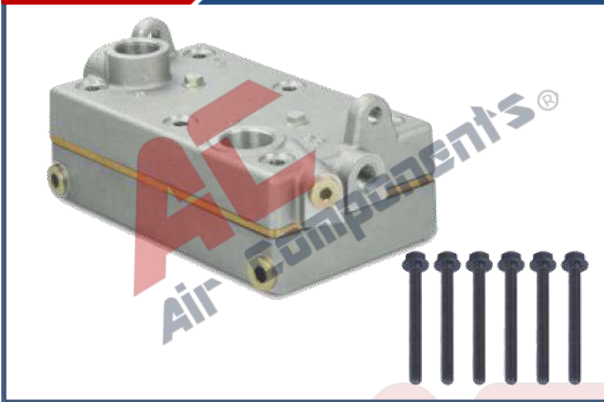

237.01.1230 PLACA DE VALVULAS



237.01.2350 REPUESTO

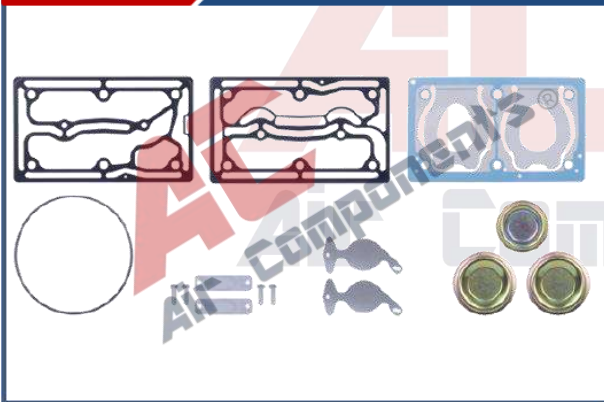

283.01.1400 BIELA



143.01.2600 BUJE



143.01.3600 ADAPTADOR



COMPRESOR HOLSET ELECTRONICO

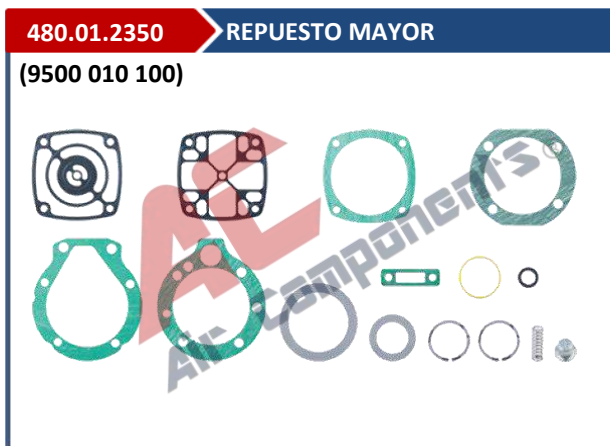

COMPRESOR WABCO TRACTOR VOLVO DOBLE 85MM

138.01.1200 CABEZA DE COMPRESOR



138.01.1230 PLACA DE VALVULAS



138.01.2350 REPUESTO MAYOR

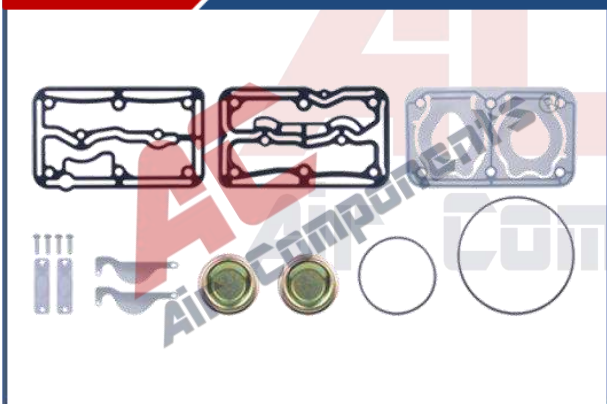

138.01.2300 REPUESTO MAYOR CON BUJE

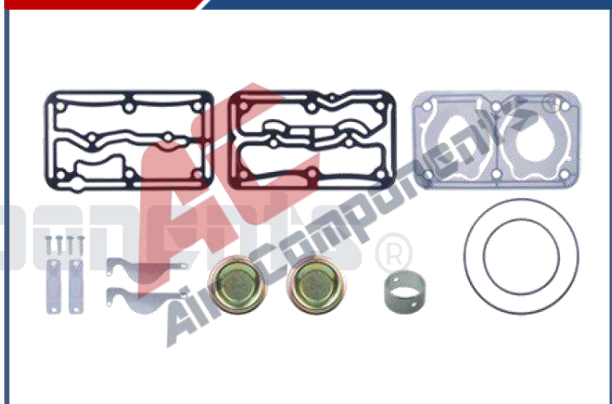

138.01.2600 BUJE



102.01.1580 TUERCA CIGÜEÑAL RH ROSCA DER



COMPRESOR TRACTOR VOLVO CABEZA VOLADA 85MM

137.01.1200 CABEZA DE COMPRESOR



137.01.1230 PLACA DE VALVULAS



137.01.2300 REPUESTO MAYOR CON BUJE

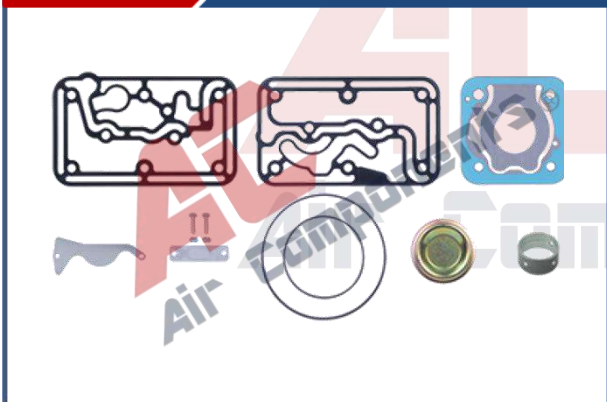

137.01.2350 REPUESTO MAYOR

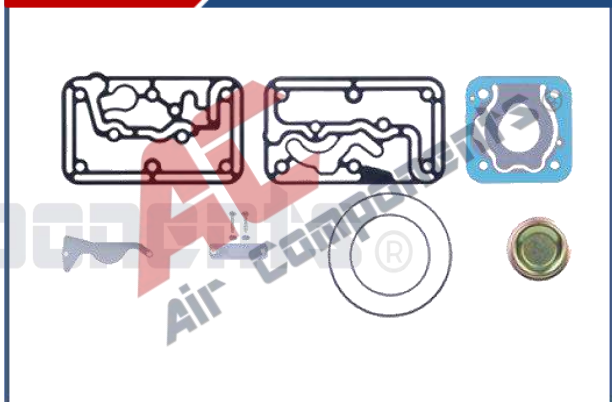

132.01.1400 BIELA



102.01.1580 TUERCA CIGÜEÑAL RH ROSCA DER



COMPRESOR VOLVO-MACK CABEZA VOLADA

136.01.1200 CABEZA

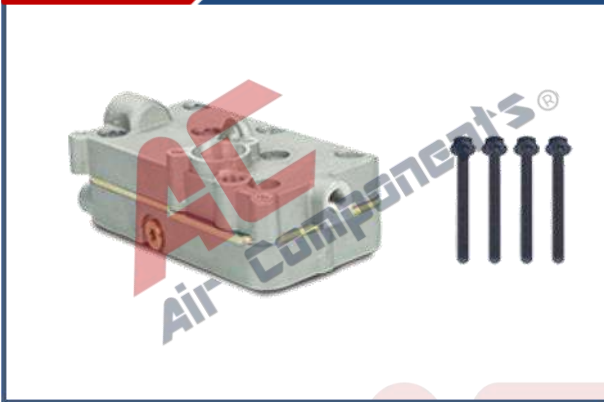

143.01.2300 REPUESTO MAYOR CON BUJE

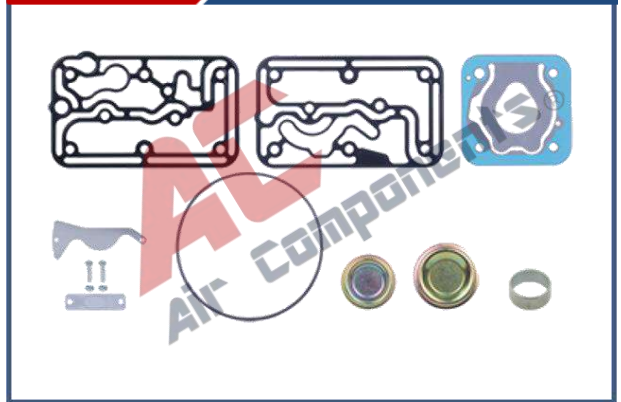

143.01.2350 REPUESTO MAYOR



143.01.3600 ADAPTADOR



143.01.2600 BUJE



143.01.1400 BIELA



COMPRESOR TU-FLO 550/750



PISTONES Y ANILLOS

PISTON CON ANILLOS DE 75 mm

218.01.1700 → STD

218.01.1710 → +0.25 mm

218.01.1720 → +0.50 mm



PISTON CON ANILLOS DE 80 mm

120.01.1700 → STD

120.01.1710 → +0.25 mm

120.01.1720 → +0.50 mm



PISTON CON ANILLOS DE 85 mm

136.01.1700 → STD

136.01.1710 → +0.25 mm

136.01.1720 → +0.50 mm

136.01.1730 → +0.75 mm



PISTON DE 85 mm

136.01.1701 → STD

136.01.1711 → +0.25 mm

136.01.1721 → +0.50 mm



PISTONES Y ANILLOS

PISTON CON ANILLOS DE 86 mm

408.01.1700	STD
408.01.1710	+0.25 mm
408.01.1720	+0.50 mm
408.01.1730	+0.75 mm



PISTON CON ANILLOS DE 88 mm

110.01.1700	STD
110.01.1710	+0.25 mm
110.01.1720	+0.50 mm



PISTON CON ANILLOS DE 90 mm

340.01.1700	STD
340.01.1710	+0.25 mm
340.01.1720	+0.50 mm



PISTON CON ANILLOS DE 92 mm

122.01.1700	STD
122.01.1710	+0.25 mm
122.01.1720	+0.50 mm



PISTONES Y ANILLOS

PISTON CON ANILLOS DE 92 mm (HOLSET)	
480.01.1700	STD
480.01.1710	+0.25 mm
480.01.1720	+0.50 mm
480.01.1730	+0.75 mm

An illustration of a piston and rings assembly. It shows a silver piston with a connecting rod end, two rings, and a separate ring. The background features a large, faint 'AC Air Components' logo.